

# LP<sup>®</sup> SOLIDSTART<sup>®</sup> LVL BEAM & HEADER U.S. (ASD) TECHNICAL GUIDE

2.0E



U.S. Technical Guide

## Introduction

# Designed to Outperform Traditional Lumber

LP® SolidStart® Laminated Veneer Lumber (LVL) is a vast improvement over traditional lumber. Problems that naturally occur as sawn lumber dries — twisting, splitting, checking, crowning and warping — are greatly reduced.

## THE STRENGTH IS IN THE ENGINEERING

LP SolidStart LVL is made from ultrasonically and visually graded veneers that are arranged in a specific pattern to maximize the strength and stiffness of the veneers and to disperse the naturally occurring characteristics of wood, such as knots, that can weaken a sawn lumber beam. The veneers are then bonded with waterproof adhesives under pressure and heat. LP SolidStart LVL beams are exceptionally strong, solid and straight, making them excellent for most primary load-carrying beam applications.

## LP SolidStart LVL 2.0E: AVAILABLE SIZES

LP SolidStart LVL 2.0E is available in a range of depths and lengths, and is available in standard thicknesses of 1-3/4" and 3-1/2". The 2.0E LVL is also available in factory-laminated thicknesses (known as "billet beam") of 5-1/4" and 7" to eliminate the need for field nailing and/or bolting of multiple plies. In addition, a water-resistant coating called SiteCote™ is applied for extra weather protection during construction. Please verify availability with the LP SolidStart Engineered Wood Products distributor in your area before specifying these products.

## LIFETIME LIMITED WARRANTY

LP SolidStart Engineered Wood Products are backed by a lifetime limited warranty. Visit [LPCorp.com](http://LPCorp.com) or call 1.888.820.0325 for a copy of the warranty.

## SOFTWARE FOR EASY, RELIABLE DESIGN

Our design/specification software enhances your in-house design capabilities. It offers accurate designs for a wide variety of applications with interfaces for printed output or plotted drawings. Through our distributors, we offer component design review services for designs using LP SolidStart Engineered Wood Products.

## CODE EVALUATION

LP SolidStart Laminated Veneer Lumber has been evaluated for compliance with major US building codes. For the most current code reports, contact your LP SolidStart Engineered Wood Products distributor, visit [LPCorp.com](http://LPCorp.com) or for:

- ICC-ES evaluation report ESR-2403 visit [www.icc-es.org](http://www.icc-es.org)
- APA Product Report® PR-L280 visit [www.apawood.org](http://www.apawood.org)

## RESPONSIBLE, SUSTAINABLE

LP Building Products uses logs from SFI® certified forest management and fiber sourcing systems to help ensure that our entire wood supply comes from well managed forests and non-controversial sources. Virtually the entire log is used in the manufacturing process, and wood waste is repurposed or used to help fuel our mills. LP Engineered Wood Products also reduce construction waste on the job site.



## IMPORTANT NOTES

1. LP SolidStart LVL shall be designed for dry-use conditions only. Dry-use applies to products installed in dry, covered and well ventilated interior conditions in which the equivalent moisture content in lumber will not exceed 16%.
2. This guide is valid only for LP SolidStart LVL members supporting loads applied parallel to the face of the veneers ("edge" orientation).
3. Ensure that the design loads, duration of load increases and deflection limits that you use to select products from this guide are appropriate for your application and comply with local code requirements. If you do not know the correct design criteria and all the loads imposed on the component from all parts of the structure, seek qualified help from the architect, engineer or designer of the structure. Additional reference data on wood construction is available in the form of building codes, code evaluation reports and other design references.
4. The Quick Reference and Allowable Load tables in this guide are only for uniform loads on simple (single) or equal, continuous (multiple) span members as noted in each table. For other conditions such as concentrated loads, unequal spans, etc., contact your LP SolidStart Engineered Wood Products distributor.
5. Spans are measured from center-to-center of supports. A structurally adequate bearing surface under the full width (thickness) of the beam must be provided at each support.
6. Minimum bearing length is 1-1/2" (at least one jack stud or cripple is required) unless otherwise noted for a specific table. Refer to the Reaction Capacity charts and the notes for each table. Verify local code requirements for minimum bearing.
7. Total load deflections are based on instantaneous loading. Long term deflection (creep) under sustained load has not been considered.
8. LP SolidStart LVL is not cambered.
9. LP SolidStart LVL sized with the tables and design values in this guide requires continuous lateral restraint of the compression edge. Continuous restraint is defined as a maximum unbraced length of 24'. This restraint is normally provided by sheathing and/or other framing members, which shall be adequately anchored to the LVL and the supporting structure. Framing conditions that do not provide continuous lateral restraint require special design. Contact your LP SolidStart Engineered Wood Products distributor. Caution: Failure to provide adequate lateral restraint could result in an unstable member and reduce its load capacity.
10. Lateral restraint shall also be provided at all supports to prevent rotation or twisting.
11. Refer to the Connection Details page for information on designing nailed and bolted connections, minimum nail spacing and end distances and for properly connecting multiple plies of LVL to form a built-up member.

# Table of Contents



## LVL 2.0E

Product Specifications & Design Values . . . . .	4
Floor Quick Reference Tables . . . . .	5
Combined Quick Reference Tables . . . . .	6-7
Roof Quick Reference Tables . . . . .	8-9
Uniform Floor Load (PLF) Tables . . . . .	10
Uniform Roof Load (PLF) Tables . . . . .	11

## GENERAL INFORMATION

Temporary Bracing & Warnings . . . . .	12
Installation Details . . . . .	13
Connection Details . . . . .	14-15
Handling and Storage Guidelines . . . . .	16

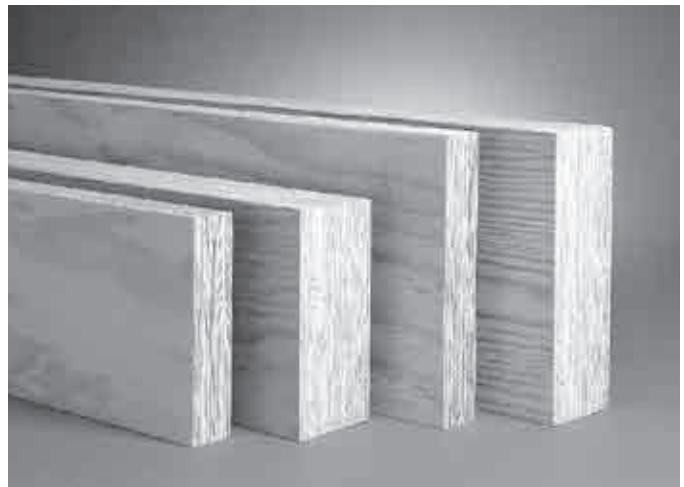

# LVL 2.OE Product Specifications & Design Values

ALLOWABLE STRESS DESIGN VALUES (PSI)					
Grade	Bending Stress <sup>3</sup> F <sub>b</sub>	Modulus of Elasticity <sup>4</sup> E (x 10 <sup>6</sup> )	Shear Stress F <sub>v</sub>	Compression Stress	
				F <sub>c</sub> (Parallel To Grain)	F <sub>c⊥</sub> (Perpendicular To Grain)
2900F <sub>b</sub> -2.OE	2900	2.0	285	3200	750

## NOTES:

- LP® SolidStart® LVL shall be designed for dry-use conditions only. Dry-use applies to products installed in dry, covered and well ventilated interior conditions in which the equivalent moisture content in lumber will not exceed 16%.
- The allowable strengths and stiffness are for normal load duration (10 year). Bending, Shear and Compression parallel-to-grain shall be adjusted according to code. Modulus of Elasticity and Compression perpendicular-to-grain shall not be adjusted.
- The allowable Bending Stress is tabulated for a standard 12" depth. For depths greater than 12", multiply F<sub>b</sub> by (12/depth)<sup>0.143</sup>. For depths less than 12", multiply F<sub>b</sub> by (12/depth)<sup>0.143</sup>. For depths less than 3-1/2", multiply F<sub>b</sub> by 1.147.
- Deflection calculations shall include both bending and shear deformations.

$$\text{Deflection for a simple span, uniform load: } \Delta = \frac{270wL^4}{Ebd^3} + \frac{28.8wL^2}{Ebd}$$

Where: Δ = deflection (in)      E = modulus of elasticity (psi)  
 w = uniform load (plf)      b = width of beam (in)  
 L = design span (ft)      d = depth of beam (in)

Equations for other conditions can be found in engineering references.

## SECTION PROPERTIES AND ALLOWABLE CAPACITIES

Depth	Weight (lb/ft)				Allowable Moment (lb-ft)				Allowable Shear (lb)				Moment of Inertia (in <sup>4</sup> )			
	1-3/4"	3-1/2"	5-1/4"	7"	1-3/4"	3-1/2"	5-1/4"	7"	1-3/4"	3-1/2"	5-1/4"	7"	1-3/4"	3-1/2"	5-1/4"	7"
7-1/4"	3.6	7.3	10.9	14.5	3918	7837	11755	15673	2411	4821	7232	9643	56	111	167	222
9-1/4"	4.6	9.3	13.9	18.5	6208	12416	18624	24832	3076	6151	9227	12303	115	231	346	462
9-1/2"	4.8	9.5	14.3	19.0	6529	13057	19586	26115	3159	6318	9476	12635	125	250	375	500
11-1/4"	5.6	11.3	16.9	22.5	8985	17970	26955	35940	3741	7481	11222	14963	208	415	623	831
11-7/8"	5.9	11.9	17.8	23.8	9951	19902	29854	39805	3948	7897	11845	15794	244	488	733	977
14"	7.0	14.0	21.0	28.0	13514	27029	40543	54057	4655	9310	13965	18620	400	800	1201	1601
16"	8.0	16.0	24.0	32.0	17318	34636	51954	69272	5320	10640	15960	21280	597	1195	1792	2389
18"	9.0	18.0	27.0	36.1	21552	43105	64657	86209	5985	11970	17955	23940	851	1701	2552	3402

## NOTES:

- The Allowable Moment and Shear capacities are for normal load duration and shall be adjusted according to code.
- The tabulated Allowable Moment capacities assume continuous lateral support of the compression edge. For other conditions, multiply the Allowable Moment by the beam stability factor, C<sub>L</sub>, as defined in the NDS.
- The 3-1/2", 5-1/4" and 7" beam widths listed above can be either a single piece or a combination of thicknesses. For example, a 7" wide beam may be a single billet beam of 7", two plies of 3-1/2", a single 1-3/4" attached to a 5-1/4" billet beam, a 3-1/2" with a 1-3/4" ply attached to each face, or four plies of 1-3/4". Refer to the Connection Assemblies details on page 14 for additional information.
- The tabulated weight is an estimate and shall only be used for design purposes. Contact LP for actual shipping weights.

## FASTENERS:

Refer to pages 14-15 for information on connecting multiple plies and for the equivalent specific gravity for design of nailed and bolted connections.

## REACTION CAPACITY (LBS)

Width	Bearing Length																					
	1-1/2"	2"	2-1/2"	3"	3-1/2"	4"	4-1/2"	5"	5-1/2"	6"	6-1/2"	7"	7-1/2"	8"	8-1/2"	9"	9-1/2"	10"	10-1/2"	11"	11-1/2"	12"
1-3/4"	1968	2625	3281	3937	4593	5250	5906	6562	7218	7875	8531	9187	9843	10500	11156	11812	12468	13125	13781	14437	15093	15750
3-1/2"	3937	5250	6562	7875	9187	10500	11812	13125	14437	15750	17062	18375	19687	21000	22312	23625	24937	26250	27562	28875	30187	31500
5-1/4"	5906	7875	9843	11812	13781	15750	17718	19687	21656	23625	25593	27562	29531	31500	33468	35437	37406	39375	41343	43312	45281	47250
7"	7875	10500	13125	15750	18375	21000	23625	26250	28875	31500	34125	36750	39375	42000	44625	47250	49875	52500	55125	57750	60375	63000

## NOTES:

- The Reaction Capacity values are based on the compression strength, perpendicular-to-grain, of the LVL. This is suitable for beams bearing on steel or the end-grain of studs.
- Verify that the support for the beam is structurally adequate to carry the reaction. The compressive strength, parallel-to-grain, of studs may require more studs than the bearing length above indicates.
- For beams bearing on wood plates, the required bearing length will increase based on the bearing strength (compression perpendicular-to-grain) of the species and grade used for the plate material.
- Verify local code requirements concerning minimum bearing.

# LVL 2.0E Floor Beam Quick Reference Tables

**TO USE:**

1. Select the correct table for the supported floor joist condition (simple or continuous – see notes below).
2. Choose the required center-to-center span for the beam in the Span column.
3. Select the span carried by the beam across the top of the table.
4. Read the beam size or choice of beam sizes from the table.

**EXAMPLE:** A beam with a 10' span carries 15'-0" simple span joists on each side.

**SOLUTION:** Using the Continuous-Span Floor Joists table with 30'-0" span carried, select either **3-1/2" x 11-1/4"** or **5-1/4" x 9-1/4"**.

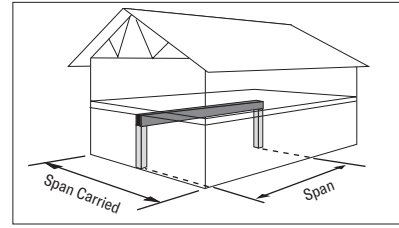

Span	Beam Width	Span Carried By Beam											
		20'	22'	24'	26'	28'	30'	32'	34'	36'	38'	40'	
6'-0"	3-1/2"	7-1/4"	7-1/4"	7-1/4"	7-1/4"	7-1/4"	7-1/4"	7-1/4"	7-1/4"	7-1/4"	7-1/4"	7-1/4"	7-1/4"
	5-1/4"	7-1/4"	7-1/4"	7-1/4"	7-1/4"	7-1/4"	7-1/4"	7-1/4"	7-1/4"	7-1/4"	7-1/4"	7-1/4"	7-1/4"
8'-0"	3-1/2"	7-1/4"	7-1/4"	9-1/4"	9-1/4"	9-1/4"	9-1/4"	9-1/4"	9-1/4"	9-1/4"	9-1/4"	9-1/4"	9-1/4"
	5-1/4"	7-1/4"	7-1/4"	7-1/4"	7-1/4"	7-1/4"	7-1/4"	7-1/4"	7-1/4"	7-1/4"	7-1/4"	7-1/4"	7-1/4"
10'-0"	3-1/2"	9-1/4"	9-1/4"	9-1/4"	9-1/2"	11-1/4"	11-1/4"	11-1/4"	11-1/4"	11-1/4"	11-1/4"	11-1/4"	11-1/4"
	5-1/4"	9-1/4"	9-1/4"	9-1/4"	9-1/4"	9-1/4"	9-1/4"	9-1/4"	9-1/4"	9-1/4"	9-1/4"	9-1/4"	9-1/2"
12'-0"	3-1/2"	11-1/4"	11-1/4"	11-1/4"	11-1/4"	11-1/4"	11-7/8"	11-7/8"	14"	14"	14"	14"	-
	5-1/4"	9-1/4"	9-1/4"	9-1/2"	11-1/4"	11-1/4"	11-1/4"	11-1/4"	11-1/4"	11-1/4"	11-1/4"	11-1/4"	11-1/4"
14'-0"	3-1/2"	14"	14"	14"	14"	14"	14"	14"	14"	-	-	-	-
	5-1/4"	11-1/4"	11-1/4"	11-1/4"	11-7/8"	11-7/8"	11-7/8"	11-7/8"	14"	14"	14"	14"	14"
16'-0"	3-1/2"	14"	16"	16"	16"	16"	16"	-	-	-	-	-	-
	5-1/4"	11-7/8"	14"	14"	14"	14"	14"	14"	14"	14"	14"	16"	16"
18'-0"	3-1/2"	16"	16"	18"	18"	-	-	-	-	-	-	-	-
	5-1/4"	14"	14"	14"	16"	16"	16"	16"	16"	16"	16"	16"	16"
20'-0"	3-1/2"	18"	18"	-	-	-	-	-	-	-	-	-	-
	5-1/4"	16"	16"	16"	16"	18"	18"	18"	18"	18"	18"	18"	-
22'-0"	3-1/2"	-	-	-	-	-	-	-	-	-	-	-	-
	5-1/4"	16"	18"	18"	18"	18"	18"	-	-	-	-	-	-
24'-0"	3-1/2"	-	-	-	-	-	-	-	-	-	-	-	-
	5-1/4"	18"	18"	-	-	-	-	-	-	-	-	-	-

Span	Beam Width	Span Carried By Beam											
		20'	22'	24'	26'	28'	30'	32'	34'	36'	38'	40'	
6'-0"	3-1/2"	7-1/4"	7-1/4"	7-1/4"	7-1/4"	7-1/4"	7-1/4"	7-1/4"	7-1/4"	7-1/4"	7-1/4"	7-1/4"	7-1/4"
	5-1/4"	7-1/4"	7-1/4"	7-1/4"	7-1/4"	7-1/4"	7-1/4"	7-1/4"	7-1/4"	7-1/4"	7-1/4"	7-1/4"	7-1/4"
8'-0"	3-1/2"	7-1/4"	7-1/4"	7-1/4"	7-1/4"	7-1/4"	7-1/4"	9-1/4"	9-1/4"	9-1/4"	9-1/4"	9-1/4"	9-1/4"
	5-1/4"	7-1/4"	7-1/4"	7-1/4"	7-1/4"	7-1/4"	7-1/4"	7-1/4"	7-1/4"	7-1/4"	7-1/4"	7-1/4"	7-1/4"
10'-0"	3-1/2"	9-1/4"	9-1/4"	9-1/4"	9-1/4"	9-1/4"	9-1/4"	9-1/2"	9-1/2"	11-1/4"	11-1/4"	11-1/4"	11-1/4"
	5-1/4"	7-1/4"	7-1/4"	9-1/4"	9-1/4"	9-1/4"	9-1/4"	9-1/4"	9-1/4"	9-1/4"	9-1/4"	9-1/4"	9-1/4"
12'-0"	3-1/2"	9-1/2"	11-1/4"	11-1/4"	11-1/4"	11-1/4"	11-1/4"	11-1/4"	11-1/4"	11-1/4"	11-7/8"	11-7/8"	14"
	5-1/4"	9-1/4"	9-1/4"	9-1/4"	9-1/4"	9-1/4"	9-1/4"	9-1/2"	11-1/4"	11-1/4"	11-1/4"	11-1/4"	11-1/4"
14'-0"	3-1/2"	11-1/4"	11-7/8"	11-7/8"	14"	14"	14"	14"	14"	14"	14"	14"	14"
	5-1/4"	11-1/4"	11-1/4"	11-1/4"	11-1/4"	11-1/4"	11-1/4"	11-1/4"	11-1/4"	11-7/8"	11-7/8"	11-7/8"	11-7/8"
16'-0"	3-1/2"	14"	14"	14"	14"	14"	14"	16"	16"	16"	16"	16"	-
	5-1/4"	11-1/4"	11-7/8"	11-7/8"	11-7/8"	14"	14"	14"	14"	14"	14"	14"	14"
18'-0"	3-1/2"	16"	16"	16"	16"	16"	16"	18"	18"	-	-	-	-
	5-1/4"	14"	14"	14"	14"	14"	14"	14"	14"	16"	16"	16"	16"
20'-0"	3-1/2"	16"	18"	18"	18"	18"	18"	-	-	-	-	-	-
	5-1/4"	14"	14"	16"	16"	16"	16"	16"	16"	16"	16"	16"	18"
22'-0"	3-1/2"	18"	18"	18"	-	-	-	-	-	-	-	-	-
	5-1/4"	16"	16"	16"	16"	18"	18"	18"	18"	18"	18"	18"	18"
24'-0"	3-1/2"	-	-	-	-	-	-	-	-	-	-	-	-
	5-1/4"	18"	18"	18"	18"	18"	18"	18"	-	-	-	-	-

**NOTES:**

1. Use the Continuous Floor Joists table where the floor joists are continuous (multiple span) over the beam. Use the Simple-Span Floor Joists table where the floor joists frame into the side of or end on top of the beam.
2. Span is center-to-center of supports and is valid for simple and equal, continuous beam spans.
3. End supports require 3" bearing. Interior supports require 6" bearing except 7-1/2" is required where **bold**. The bearing length is based on the compression strength, perpendicular-to-grain, of the LVL. See the Reaction Capacity table on page 4 for additional information.
4. Deflections are limited to L/360 live load and L/240 total load.
5. Beam width can be either a single piece of LVL or built up from multiple plies that are nailed, bolted or connected with other approved fasteners. Refer to pages 14-15 for connection details.
6. Do not use where marked "-".

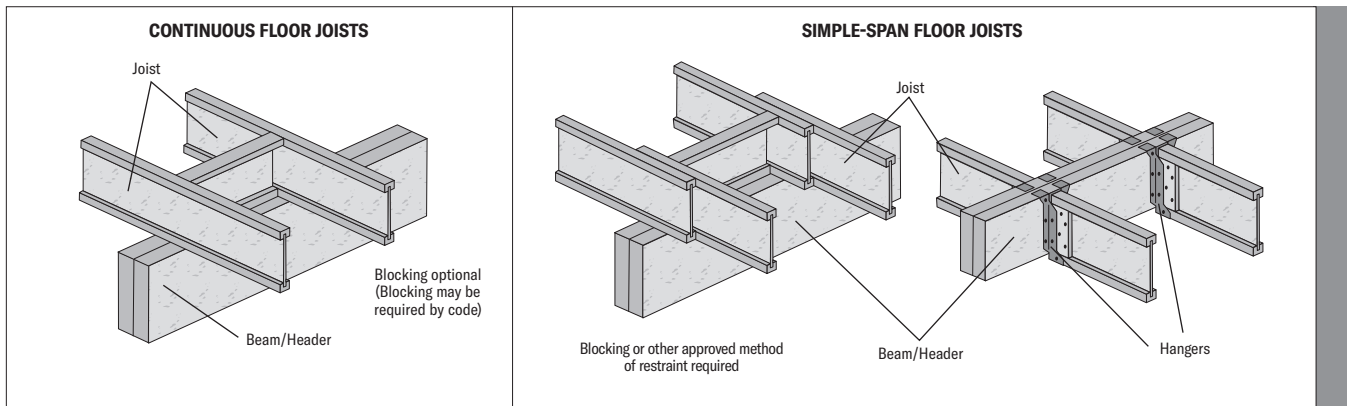

# LVL 2.0E Combined Beam Quick Reference Tables

## TO USE:

1. Select the correct table for the roof loads needed.
2. Choose the required center-to-center span for the beam in the Span column.
3. Select the span carried by the beam across the top of the table.
4. Read the beam size or choice of beam sizes from the table.

**EXAMPLE:** A beam with a 9'-6" span supports a 32'-0" span carried for a 20 psf roof live load.

**SOLUTION:** Using the correct table for the roof load with 32'-0" span carried, select either **3-1/2" x 11-1/4"** or **5-1/4" x 9-1/4"**.

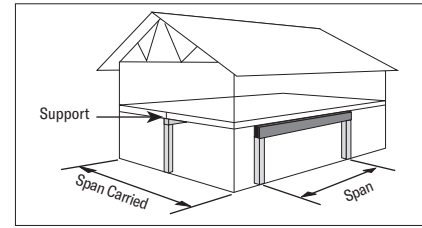

Span	Beam Width	Span Carried By Beam											
		20'	22'	24'	26'	28'	30'	32'	34'	36'	38'	40'	
6'-0"	3-1/2"	7-1/4"	7-1/4"	7-1/4"	7-1/4"	7-1/4"	7-1/4"	7-1/4"	7-1/4"	7-1/4"	7-1/4"	7-1/4"	7-1/4"
	5-1/4"	7-1/4"	7-1/4"	7-1/4"	7-1/4"	7-1/4"	7-1/4"	7-1/4"	7-1/4"	7-1/4"	7-1/4"	7-1/4"	7-1/4"
8'-0"	3-1/2"	7-1/4"	7-1/4"	9-1/4"	9-1/4"	9-1/4"	9-1/4"	9-1/4"	9-1/4"	9-1/4"	9-1/4"	9-1/4"	9-1/4"
	5-1/4"	7-1/4"	7-1/4"	7-1/4"	7-1/4"	7-1/4"	7-1/4"	7-1/4"	7-1/4"	7-1/4"	9-1/4"	9-1/4"	9-1/4"
9'-6"	3-1/2"	9-1/4"	9-1/4"	9-1/4"	9-1/4"	9-1/4"	9-1/4"	9-1/2"	11-1/4"	11-1/4"	11-1/4"	11-1/4"	11-1/4"
	5-1/4"	7-1/4"	9-1/4"	9-1/4"	9-1/4"	9-1/4"	9-1/4"	9-1/4"	9-1/4"	9-1/4"	9-1/4"	9-1/4"	9-1/4"
10'-0"	3-1/2"	9-1/4"	9-1/4"	9-1/4"	9-1/2"	11-1/4"	11-1/4"	11-1/4"	11-1/4"	11-1/4"	11-1/4"	11-1/4"	11-1/4"
	5-1/4"	9-1/4"	9-1/4"	9-1/4"	9-1/4"	9-1/4"	9-1/4"	9-1/4"	9-1/4"	9-1/4"	9-1/4"	9-1/4"	9-1/2"
12'-0"	3-1/2"	11-1/4"	11-1/4"	11-1/4"	11-7/8"	11-7/8"	11-7/8"	14"	14"	14"	14"	14"	14"
	5-1/4"	9-1/4"	9-1/2"	11-1/4"	11-1/4"	11-1/4"	11-1/4"	11-1/4"	11-1/4"	11-1/4"	11-1/4"	11-1/4"	11-1/4"
14'-0"	3-1/2"	14"	14"	14"	14"	14"	14"	14"	14"	16"	16"	16"	16"
	5-1/4"	11-1/4"	11-1/4"	11-1/4"	11-7/8"	11-7/8"	14"	14"	14"	14"	14"	14"	14"
16'-0"	3-1/2"	16"	16"	16"	16"	16"	16"	16"	16"	16"	18"	18"	18"
	5-1/4"	14"	14"	14"	14"	14"	14"	14"	14"	16"	16"	16"	16"
16'-6"	3-1/2"	16"	16"	16"	-	-	-	-	-	-	-	-	-
	5-1/4"	14"	14"	14"	14"	14"	16"	16"	16"	16"	16"	16"	16"
18'-0"	3-1/2"	16"	18"	18"	18"	18"	18"	18"	18"	-	-	-	-
	5-1/4"	14"	16"	16"	16"	16"	16"	16"	16"	16"	18"	18"	18"
18'-6"	3-1/2"	18"	-	-	-	-	-	-	-	-	-	-	-
	5-1/4"	16"	16"	16"	16"	16"	16"	16"	18"	18"	-	-	-
20'-0"	3-1/2"	18"	18"	-	-	-	-	-	-	-	-	-	-
	5-1/4"	16"	16"	16"	18"	18"	18"	18"	18"	18"	-	-	-
22'-0"	3-1/2"	-	-	-	-	-	-	-	-	-	-	-	-
	5-1/4"	18"	18"	18"	18"	-	-	-	-	-	-	-	-
24'-0"	3-1/2"	-	-	-	-	-	-	-	-	-	-	-	-
	5-1/4"	-	-	-	-	-	-	-	-	-	-	-	-

Span	Beam Width	Span Carried By Beam											
		20'	22'	24'	26'	28'	30'	32'	34'	36'	38'	40'	
6'-0"	3-1/2"	7-1/4"	7-1/4"	7-1/4"	7-1/4"	7-1/4"	7-1/4"	7-1/4"	7-1/4"	7-1/4"	7-1/4"	7-1/4"	7-1/4"
	5-1/4"	7-1/4"	7-1/4"	7-1/4"	7-1/4"	7-1/4"	7-1/4"	7-1/4"	7-1/4"	7-1/4"	7-1/4"	7-1/4"	7-1/4"
8'-0"	3-1/2"	7-1/4"	9-1/4"	9-1/4"	9-1/4"	9-1/4"	9-1/4"	9-1/4"	9-1/4"	9-1/4"	9-1/4"	9-1/4"	9-1/4"
	5-1/4"	7-1/4"	7-1/4"	7-1/4"	7-1/4"	7-1/4"	7-1/4"	7-1/4"	9-1/4"	9-1/4"	9-1/4"	9-1/4"	9-1/4"
9'-6"	3-1/2"	9-1/4"	9-1/4"	9-1/4"	9-1/4"	9-1/2"	11-1/4"	11-1/4"	11-1/4"	11-1/4"	11-1/4"	11-1/4"	11-1/4"
	5-1/4"	9-1/4"	9-1/4"	9-1/4"	9-1/4"	9-1/4"	9-1/4"	9-1/4"	9-1/4"	9-1/4"	9-1/4"	9-1/4"	9-1/4"
10'-0"	3-1/2"	9-1/4"	9-1/4"	9-1/2"	11-1/4"	11-1/4"	11-1/4"	11-1/4"	11-1/4"	11-1/4"	11-1/4"	11-1/4"	11-1/4"
	5-1/4"	9-1/4"	9-1/4"	9-1/4"	9-1/4"	9-1/4"	9-1/4"	9-1/4"	9-1/4"	9-1/4"	9-1/2"	11-1/4"	11-1/4"
12'-0"	3-1/2"	11-1/4"	11-1/4"	11-1/4"	11-7/8"	11-7/8"	14"	14"	14"	14"	14"	14"	14"
	5-1/4"	9-1/2"	11-1/4"	11-1/4"	11-1/4"	11-1/4"	11-1/4"	11-1/4"	11-1/4"	11-1/4"	11-1/4"	11-1/4"	11-7/8"
14'-0"	3-1/2"	14"	14"	14"	14"	14"	14"	16"	16"	16"	16"	16"	16"
	5-1/4"	11-1/4"	11-1/4"	11-7/8"	11-7/8"	14"	14"	14"	14"	14"	14"	14"	14"
16'-0"	3-1/2"	16"	16"	16"	16"	16"	16"	16"	16"	16"	18"	18"	-
	5-1/4"	14"	14"	14"	14"	14"	14"	16"	16"	16"	16"	16"	16"
16'-6"	3-1/2"	16"	16"	-	-	-	-	-	-	-	-	-	-
	5-1/4"	14"	14"	14"	14"	14"	16"	16"	16"	16"	16"	16"	16"
18'-0"	3-1/2"	18"	18"	18"	18"	18"	-	-	-	-	-	-	-
	5-1/4"	16"	16"	16"	16"	16"	16"	16"	18"	18"	18"	18"	18"
18'-6"	3-1/2"	-	-	-	-	-	-	-	-	-	-	-	-
	5-1/4"	16"	16"	16"	16"	16"	18"	18"	-	-	-	-	-
20'-0"	3-1/2"	18"	-	-	-	-	-	-	-	-	-	-	-
	5-1/4"	16"	18"	18"	18"	18"	18"	18"	18"	-	-	-	-
22'-0"	3-1/2"	-	-	-	-	-	-	-	-	-	-	-	-
	5-1/4"	18"	18"	-	-	-	-	-	-	-	-	-	-
24'-0"	3-1/2"	-	-	-	-	-	-	-	-	-	-	-	-
	5-1/4"	-	-	-	-	-	-	-	-	-	-	-	-

## NOTES:

1. Span is center-to-center of supports and is valid for simple beam spans only.
2. End supports require 3" bearing except 4-1/2" is required where **bold**. The end supports for the standard garage door spans of 9'-6", 16'-6" and 18'-6" have been limited to 3" (two trimmers) on each end. The bearing length is based on the compression strength, perpendicular-to-grain, of the LVL. See the Reaction Capacity table on page 4 for additional information.
3. Deflections are limited to L/360 live or snow load and L/240 total load.
4. Loads include 100 plf for an exterior wall and assume a 2' maximum overhang on the roof and an interior support at mid-span of the floor joists.
5. Beam width can be either a single piece of LVL or built up from multiple plies that are nailed, bolted or connected with other approved fasteners. Refer to pages 14-15 for connection details.
6. Do not use where marked "-".

# LVL 2.0E Combined Beam Quick Reference Tables

## TO USE:

1. Select the correct table for the roof loads needed.
2. Choose the required center-to-center span for the beam in the Span column.
3. Select the span carried by the beam across the top of the table.
4. Read the beam size or choice of beam sizes from the table.

**EXAMPLE:** A beam with a 9'-6" span supports a 32'-0" span carried for a 40 psf roof snow load.

**SOLUTION:** Using the correct table for the roof load with 32'-0" span carried, select either **3-1/2" x 11-1/4"** or **5-1/4" x 9-1/4"**.

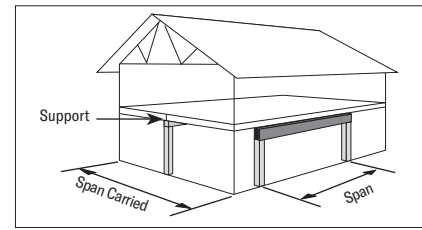

DESIGN LOADS ROOF: 30 PSF SNOW (115%), 15 PSF DEAD FLOOR: 40 PSF LIVE, 15 PSF DEAD	Span	Beam Width	Span Carried By Beam										
			20'	22'	24'	26'	28'	30'	32'	34'	36'	38'	40'
			6'-0"	3-1/2" 5-1/4"	7-1/4" 7-1/4"	7-1/4" 7-1/4"	7-1/4" 7-1/4"	7-1/4" 7-1/4"	7-1/4" 7-1/4"	7-1/4" 7-1/4"	7-1/4" 7-1/4"	7-1/4" 7-1/4"	7-1/4" 7-1/4"
8'-0"	3-1/2" 5-1/4"	9-1/4" 7-1/4"	9-1/4" 7-1/4"	9-1/4" 7-1/4"	9-1/4" 7-1/4"	9-1/4" 7-1/4"	9-1/4" 7-1/4"	9-1/4" 9-1/4"	9-1/4" 9-1/4"	9-1/4" 9-1/4"	9-1/4" 9-1/4"	9-1/4" 9-1/4"	
9'-6"	3-1/2" 5-1/4"	9-1/4" 9-1/4"	9-1/4" 9-1/4"	9-1/4" 9-1/4"	9-1/4" 9-1/4"	9-1/2" 9-1/4"	11-1/4" 9-1/4"	11-1/4" 9-1/4"	11-1/4" 9-1/4"	11-1/4" 9-1/4"	11-1/4" 9-1/4"	11-1/4" 9-1/4"	11-1/4" 9-1/2"
10'-0"	3-1/2" 5-1/4"	9-1/4" 9-1/4"	9-1/2" 9-1/4"	11-1/4" 9-1/4"	11-1/4" 9-1/4"	11-1/4" 9-1/4"	11-1/4" 9-1/4"	11-1/4" 9-1/4"	11-1/4" 9-1/2"	11-1/4" 9-1/2"	11-1/4" 11-1/4"	11-1/4" 11-1/4"	11-7/8" 11-1/4"
12'-0"	3-1/2" 5-1/4"	11-1/4" 11-1/4"	11-7/8" 11-1/4"	11-7/8" 11-1/4"	14" 11-1/4"	14" 11-1/4"	14" 11-1/4"	14" 11-1/4"	14" 11-1/4"	14" 11-7/8"	14" 11-7/8"	14" 11-7/8"	14" 11-7/8"
14'-0"	3-1/2" 5-1/4"	14" 11-1/4"	14" 11-7/8"	14" 11-7/8"	14" 14"	16" 14"	16" 14"	16" 14"	16" 14"	16" 14"	16" 14"	16" 14"	16" 14"
16'-0"	3-1/2" 5-1/4"	16" 14"	16" 14"	16" 14"	16" 14"	16" 16"	18" 16"	18" 16"	18" 16"	18" 16"	18" 16"	18" 16"	18" 16"
16'-6"	3-1/2" 5-1/4"	16" 14"	- 14"	- 14"	- 16"	- 16"	- 16"	- 16"	- 16"	- 16"	- 16"	- 16"	- 16"
18'-0"	3-1/2" 5-1/4"	18" 16"	18" 16"	18" 16"	18" 16"	18" 16"	- 18"	- 18"	- 18"	- 18"	- 18"	- 18"	- 18"
18'-6"	3-1/2" 5-1/4"	- 16"	- 16"	- 16"	- 16"	- 18"	- 18"	- 18"	- 18"	- 18"	- 18"	- 18"	- 18"
20'-0"	3-1/2" 5-1/4"	- 16"	- 18"	- 18"	- 18"	- 18"	- 18"	- 18"	- 18"	- 18"	- 18"	- 18"	- 18"
22'-0"	3-1/2" 5-1/4"	- 18"	- 18"	- 18"	- 18"	- 18"	- 18"	- 18"	- 18"	- 18"	- 18"	- 18"	- 18"
24'-0"	3-1/2" 5-1/4"	- 18"	- 18"	- 18"	- 18"	- 18"	- 18"	- 18"	- 18"	- 18"	- 18"	- 18"	- 18"

DESIGN LOADS ROOF: 40 PSF SNOW (115%), 15 PSF DEAD FLOOR: 40 PSF LIVE, 15 PSF DEAD	Span	Beam Width	Span Carried By Beam										
			20'	22'	24'	26'	28'	30'	32'	34'	36'	38'	40'
			6'-0"	3-1/2" 5-1/4"	7-1/4" 7-1/4"	7-1/4" 7-1/4"	7-1/4" 7-1/4"	7-1/4" 7-1/4"	7-1/4" 7-1/4"	7-1/4" 7-1/4"	7-1/4" 7-1/4"	7-1/4" 7-1/4"	7-1/4" 7-1/4"
8'-0"	3-1/2" 5-1/4"	9-1/4" 7-1/4"	9-1/4" 7-1/4"	9-1/4" 7-1/4"	9-1/4" 7-1/4"	9-1/4" 7-1/4"	9-1/4" 9-1/4"	9-1/4" 9-1/4"	9-1/4" 9-1/4"	9-1/4" 9-1/4"	9-1/4" 9-1/4"	9-1/2" 9-1/4"	11-1/4" 9-1/4"
9'-6"	3-1/2" 5-1/4"	9-1/4" 9-1/4"	9-1/2" 9-1/4"	11-1/4" 9-1/4"	11-1/4" 9-1/4"	11-1/4" 9-1/4"	11-1/4" 9-1/4"	11-1/4" 9-1/4"	11-1/4" 9-1/2"	11-1/4" 9-1/2"	- 11-1/4"	- 11-1/4"	- 11-1/4"
10'-0"	3-1/2" 5-1/4"	11-1/4" 9-1/4"	11-1/4" 9-1/4"	11-1/4" 9-1/4"	11-1/4" 9-1/4"	11-1/4" 9-1/4"	11-1/4" 9-1/2"	11-1/4" 9-1/2"	11-1/4" 11-7/8"	11-1/4" 11-7/8"	11-1/4" 11-7/8"	11-1/4" 11-7/8"	14" 11-1/4"
12'-0"	3-1/2" 5-1/4"	11-7/8" 11-1/4"	11-7/8" 11-1/4"	14" 11-1/4"	14" 11-1/4"	14" 11-1/4"	14" 11-1/4"	14" 11-7/8"	14" 11-7/8"	14" 14"	14" 14"	14" 14"	16" 14"
14'-0"	3-1/2" 5-1/4"	14" 11-7/8"	14" 14"	16" 14"	16" 14"	16" 14"	16" 14"	16" 14"	16" 14"	16" 14"	18" 14"	- 16"	- 16"
16'-0"	3-1/2" 5-1/4"	16" 14"	16" 14"	16" 16"	16" 16"	16" 16"	16" 16"	16" 16"	16" 16"	16" 16"	16" 16"	16" 16"	18" 18"
16'-6"	3-1/2" 5-1/4"	- 14"	- 16"	- 16"	- 16"	- 16"	- 16"	- 16"	- 16"	- 16"	- 16"	- 16"	- 16"
18'-0"	3-1/2" 5-1/4"	18" 16"	18" 16"	- 16"	- 18"	- 18"	- 18"	- 18"	- 18"	- 18"	- 18"	- 18"	- 18"
18'-6"	3-1/2" 5-1/4"	- 16"	- 16"	- 18"	- 18"	- 18"	- 18"	- 18"	- 18"	- 18"	- 18"	- 18"	- 18"
20'-0"	3-1/2" 5-1/4"	- 18"	- 18"	- 18"	- 18"	- 18"	- 18"	- 18"	- 18"	- 18"	- 18"	- 18"	- 18"
22'-0"	3-1/2" 5-1/4"	- 18"	- 18"	- 18"	- 18"	- 18"	- 18"	- 18"	- 18"	- 18"	- 18"	- 18"	- 18"
24'-0"	3-1/2" 5-1/4"	- 18"	- 18"	- 18"	- 18"	- 18"	- 18"	- 18"	- 18"	- 18"	- 18"	- 18"	- 18"

## NOTES:

1. Span is center-to-center of supports and is valid for simple beam spans only.
2. End supports require 3" bearing except 4-1/2" is required where **bold**. The end supports for the standard garage door spans of 9'-6", 16'-6" and 18'-6" have been limited to 3" (two trimmers) on each end. The bearing length is based on the compression strength, perpendicular-to-grain, of the LVL. See the Reaction Capacity table on page 4 for additional information.
3. Deflections are limited to L/360 live or snow load and L/240 total load.
4. Loads include 100 plf for an exterior wall and assume a 2' maximum overhang on the roof and an interior support at mid-span of the floor joists.
5. Beam width can be either a single piece of LVL or built up from multiple plies that are nailed, bolted or connected with other approved fasteners. Refer to pages 14-15 for connection details.
6. Do not use where marked "-".

# LVL 2.0E Roof Beam Quick Reference Tables

## TO USE:

1. Select the correct table for the roof loads needed.
2. Choose the required center-to-center span for the beam in the Span column.
3. Select the span carried by the beam across the top of the table.
4. Read the beam size or choice of beam sizes from the table.

**EXAMPLE:** A beam with a 16'-6" span supports a 38'-0" span carried for a 25 psf roof snow load.

**SOLUTION:** Using the correct table for the roof load with 38'-0" span carried, select either 3-1/2" x 16" or 5-1/4" x 14".

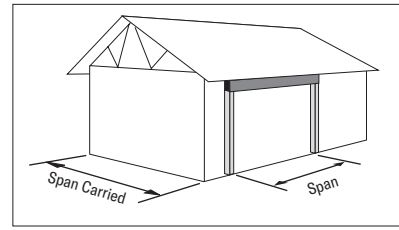

DESIGN LOADS ROOF: 20 PSF SNOW OR LIVE (115% or 125%), 15 PSF DEAD	Span	Beam Width	Span Carried By Beam										
			20'	22'	24'	26'	28'	30'	32'	34'	36'	38'	40'
			6'-0"	3-1/2"	7-1/4"	7-1/4"	7-1/4"	7-1/4"	7-1/4"	7-1/4"	7-1/4"	7-1/4"	7-1/4"
8'-0"	3-1/2"	7-1/4"	7-1/4"	7-1/4"	7-1/4"	7-1/4"	7-1/4"	7-1/4"	7-1/4"	7-1/4"	7-1/4"	7-1/4"	7-1/4"
	5-1/4"	7-1/4"	7-1/4"	7-1/4"	7-1/4"	7-1/4"	7-1/4"	7-1/4"	7-1/4"	7-1/4"	7-1/4"	7-1/4"	7-1/4"
9'-6"	3-1/2"	7-1/4"	7-1/4"	7-1/4"	7-1/4"	7-1/4"	9-1/4"	9-1/4"	9-1/4"	9-1/4"	9-1/4"	9-1/4"	9-1/4"
	5-1/4"	7-1/4"	7-1/4"	7-1/4"	7-1/4"	7-1/4"	9-1/4"	9-1/4"	9-1/4"	9-1/4"	9-1/4"	9-1/4"	9-1/4"
10'-0"	3-1/2"	7-1/4"	7-1/4"	9-1/4"	9-1/4"	9-1/4"	9-1/4"	9-1/4"	9-1/4"	9-1/4"	9-1/4"	9-1/4"	9-1/4"
	5-1/4"	7-1/4"	7-1/4"	7-1/4"	7-1/4"	7-1/4"	7-1/4"	7-1/4"	7-1/4"	7-1/4"	9-1/4"	9-1/4"	9-1/4"
12'-0"	3-1/2"	9-1/4"	9-1/4"	9-1/4"	9-1/4"	9-1/4"	9-1/2"	11-1/4"	11-1/4"	11-1/4"	11-1/4"	11-1/4"	11-1/4"
	5-1/4"	9-1/4"	9-1/4"	9-1/4"	9-1/4"	9-1/4"	9-1/4"	9-1/4"	9-1/4"	9-1/4"	9-1/4"	9-1/4"	9-1/4"
14'-0"	3-1/2"	11-1/4"	11-1/4"	11-1/4"	11-1/4"	11-1/4"	11-1/4"	11-1/4"	11-7/8"	11-7/8"	11-7/8"	14"	14"
	5-1/4"	9-1/4"	9-1/4"	9-1/4"	9-1/2"	9-1/2"	11-1/4"	11-1/4"	11-1/4"	11-1/4"	11-1/4"	11-1/4"	11-1/4"
16'-0"	3-1/2"	11-7/8"	11-7/8"	14"	14"	14"	14"	14"	14"	14"	14"	14"	14"
	5-1/4"	11-1/4"	11-1/4"	11-1/4"	11-1/4"	11-1/4"	11-1/4"	11-7/8"	11-7/8"	11-7/8"	14"	14"	14"
16'-6"	3-1/2"	11-7/8"	14"	14"	14"	14"	14"	14"	14"	14"	14"	16"	16"
	5-1/4"	11-1/4"	11-1/4"	11-1/4"	11-1/4"	11-1/4"	11-7/8"	11-7/8"	11-7/8"	14"	14"	14"	14"
18'-0"	3-1/2"	14"	14"	14"	14"	16"	16"	16"	16"	16"	16"	16"	16"
	5-1/4"	11-1/4"	11-7/8"	11-7/8"	14"	14"	14"	14"	14"	14"	14"	14"	14"
18'-6"	3-1/2"	14"	14"	14"	16"	16"	16"	16"	16"	16"	16"	16"	18"
	5-1/4"	11-7/8"	11-7/8"	14"	14"	14"	14"	14"	14"	14"	14"	14"	14"
20'-0"	3-1/2"	16"	16"	16"	16"	16"	16"	18"	18"	18"	18"	18"	18"
	5-1/4"	14"	14"	14"	14"	14"	14"	16"	16"	16"	16"	16"	16"
22'-0"	3-1/2"	16"	16"	18"	18"	18"	18"	18"	18"	-	-	-	-
	5-1/4"	14"	14"	16"	16"	16"	16"	16"	16"	16"	18"	18"	18"
24'-0"	3-1/2"	18"	18"	18"	-	-	-	-	-	-	-	-	-
	5-1/4"	16"	16"	16"	16"	18"	18"	18"	18"	18"	18"	18"	-

DESIGN LOADS ROOF: 25 PSF SNOW (115%), 15 PSF DEAD	Span	Beam Width	Span Carried By Beam										
			20'	22'	24'	26'	28'	30'	32'	34'	36'	38'	40'
			6'-0"	3-1/2"	7-1/4"	7-1/4"	7-1/4"	7-1/4"	7-1/4"	7-1/4"	7-1/4"	7-1/4"	7-1/4"
8'-0"	3-1/2"	7-1/4"	7-1/4"	7-1/4"	7-1/4"	7-1/4"	7-1/4"	7-1/4"	7-1/4"	7-1/4"	7-1/4"	7-1/4"	9-1/4"
	5-1/4"	7-1/4"	7-1/4"	7-1/4"	7-1/4"	7-1/4"	7-1/4"	7-1/4"	7-1/4"	7-1/4"	7-1/4"	7-1/4"	7-1/4"
9'-6"	3-1/2"	7-1/4"	7-1/4"	9-1/4"	9-1/4"	9-1/4"	9-1/4"	9-1/4"	9-1/4"	9-1/4"	9-1/4"	9-1/4"	9-1/4"
	5-1/4"	7-1/4"	7-1/4"	7-1/4"	7-1/4"	7-1/4"	7-1/4"	7-1/4"	7-1/4"	7-1/4"	7-1/4"	9-1/4"	9-1/4"
10'-0"	3-1/2"	9-1/4"	9-1/4"	9-1/4"	9-1/4"	9-1/4"	9-1/4"	9-1/4"	9-1/4"	9-1/4"	9-1/4"	9-1/4"	9-1/4"
	5-1/4"	7-1/4"	7-1/4"	7-1/4"	7-1/4"	7-1/4"	7-1/4"	7-1/4"	9-1/4"	9-1/4"	9-1/4"	9-1/4"	9-1/4"
12'-0"	3-1/2"	9-1/4"	9-1/4"	9-1/2"	11-1/4"	11-1/4"	11-1/4"	11-1/4"	11-1/4"	11-1/4"	11-1/4"	11-1/4"	11-1/4"
	5-1/4"	9-1/4"	9-1/4"	9-1/4"	9-1/4"	9-1/4"	9-1/4"	9-1/4"	9-1/4"	9-1/4"	9-1/4"	9-1/2"	9-1/2"
14'-0"	3-1/2"	11-1/4"	11-1/4"	11-1/4"	11-1/4"	11-1/4"	11-7/8"	11-7/8"	11-7/8"	14"	14"	14"	14"
	5-1/4"	9-1/4"	9-1/4"	9-1/2"	11-1/4"	11-1/4"	11-1/4"	11-1/4"	11-1/4"	11-1/4"	11-1/4"	11-1/4"	11-1/4"
16'-0"	3-1/2"	11-7/8"	14"	14"	14"	14"	14"	14"	14"	14"	14"	16"	16"
	5-1/4"	11-1/4"	11-1/4"	11-1/4"	11-1/4"	11-7/8"	11-7/8"	11-7/8"	14"	14"	14"	14"	14"
16'-6"	3-1/2"	14"	14"	14"	14"	14"	14"	14"	14"	16"	16"	16"	16"
	5-1/4"	11-1/4"	11-1/4"	11-1/4"	11-7/8"	11-7/8"	14"	14"	14"	14"	14"	14"	14"
18'-0"	3-1/2"	14"	14"	16"	16"	16"	16"	16"	16"	16"	16"	18"	18"
	5-1/4"	11-7/8"	14"	14"	14"	14"	14"	14"	14"	14"	14"	16"	16"
18'-6"	3-1/2"	14"	16"	16"	16"	16"	16"	16"	16"	16"	18"	-	-
	5-1/4"	14"	14"	14"	14"	14"	14"	14"	14"	14"	16"	16"	16"
20'-0"	3-1/2"	16"	16"	16"	16"	18"	18"	18"	18"	18"	18"	18"	-
	5-1/4"	14"	14"	14"	14"	16"	16"	16"	16"	16"	16"	16"	16"
22'-0"	3-1/2"	18"	18"	18"	18"	18"	-	-	-	-	-	-	-
	5-1/4"	16"	16"	16"	16"	16"	16"	18"	18"	18"	18"	18"	18"
24'-0"	3-1/2"	18"	-	-	-	-	-	-	-	-	-	-	-
	5-1/4"	16"	16"	18"	18"	18"	18"	18"	18"	-	-	-	-

## NOTES:

1. Span is center-to-center of supports and is valid for simple beam spans only.
2. End supports require 3" bearing except 4-1/2" is required where **bold**. The end supports for the standard garage door spans of 9'-6", 16'-6" and 18'-6" have been limited to 3" (two trimmers) on each end. The bearing length is based on the compression strength, perpendicular-to-grain, of the LVL. See the Reaction Capacity table on page 4 for additional information.
3. Deflections are limited to L/360 live or snow load and L/240 total load.
4. Loads assume a 2" maximum overhang on the roof.
5. Beam width can be either a single piece of LVL or built up from multiple plies that are nailed, bolted or connected with other approved fasteners. Refer to pages 14-15 for connection details.
6. Do not use where marked "-".



# LVL 2.0E Roof Beam Quick Reference Tables

**TO USE:**

1. Select the correct table for the roof loads needed.
2. Choose the required center-to-center span for the beam in the Span column.
3. Select the span carried by the beam across the top of the table.
4. Read the beam size or choice of beam sizes from the table.

**EXAMPLE:** A beam with a 16'-6" span supports a 38'-0" span carried for a 40 psf roof snow load.

**SOLUTION:** Using the correct table for the roof load with 38'-0" span carried, select a **5-1/4" x 16"**.

**NOTE:** A 3-1/2" beam does not work.

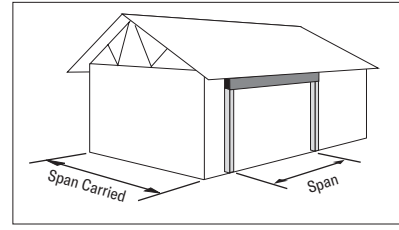

Span	Beam Width	Span Carried By Beam											
		20'	22'	24'	26'	28'	30'	32'	34'	36'	38'	40'	
6'-0"	3-1/2"	7-1/4"	7-1/4"	7-1/4"	7-1/4"	7-1/4"	7-1/4"	7-1/4"	7-1/4"	7-1/4"	7-1/4"	7-1/4"	7-1/4"
	5-1/4"	7-1/4"	7-1/4"	7-1/4"	7-1/4"	7-1/4"	7-1/4"	7-1/4"	7-1/4"	7-1/4"	7-1/4"	7-1/4"	7-1/4"
8'-0"	3-1/2"	7-1/4"	7-1/4"	7-1/4"	7-1/4"	7-1/4"	7-1/4"	7-1/4"	7-1/4"	7-1/4"	7-1/4"	7-1/4"	7-1/4"
	5-1/4"	7-1/4"	7-1/4"	7-1/4"	7-1/4"	7-1/4"	7-1/4"	7-1/4"	7-1/4"	7-1/4"	7-1/4"	7-1/4"	7-1/4"
9'-6"	3-1/2"	9-1/4"	9-1/4"	9-1/4"	9-1/4"	9-1/4"	9-1/4"	9-1/4"	9-1/4"	9-1/4"	9-1/4"	9-1/4"	9-1/4"
	5-1/4"	7-1/4"	7-1/4"	7-1/4"	7-1/4"	7-1/4"	7-1/4"	7-1/4"	7-1/4"	7-1/4"	7-1/4"	7-1/4"	7-1/4"
10'-0"	3-1/2"	9-1/4"	9-1/4"	9-1/4"	9-1/4"	9-1/4"	9-1/4"	9-1/4"	9-1/4"	9-1/4"	9-1/4"	9-1/2"	9-1/2"
	5-1/4"	7-1/4"	7-1/4"	7-1/4"	7-1/4"	7-1/4"	7-1/4"	7-1/4"	7-1/4"	7-1/4"	7-1/4"	9-1/4"	9-1/4"
12'-0"	3-1/2"	9-1/4"	9-1/2"	11-1/4"	11-1/4"	11-1/4"	11-1/4"	11-1/4"	11-1/4"	11-1/4"	11-1/4"	11-1/4"	11-7/8"
	5-1/4"	9-1/4"	9-1/4"	9-1/4"	9-1/4"	9-1/4"	9-1/4"	9-1/4"	9-1/4"	9-1/4"	9-1/2"	11-1/4"	11-1/4"
14'-0"	3-1/2"	11-1/4"	11-1/4"	11-7/8"	11-7/8"	11-7/8"	14"	14"	14"	14"	14"	14"	14"
	5-1/4"	9-1/2"	11-1/4"	11-1/4"	11-1/4"	11-1/4"	11-1/4"	11-1/4"	11-1/4"	11-1/4"	11-1/4"	11-7/8"	11-7/8"
16'-0"	3-1/2"	14"	14"	14"	14"	14"	14"	16"	16"	16"	16"	16"	16"
	5-1/4"	11-1/4"	11-1/4"	11-7/8"	11-7/8"	11-7/8"	14"	14"	14"	14"	14"	14"	14"
16'-6"	3-1/2"	14"	14"	14"	14"	14"	16"	16"	16"	16"	-	-	-
	5-1/4"	11-1/4"	11-7/8"	11-7/8"	14"	14"	14"	14"	14"	14"	14"	14"	14"
18'-0"	3-1/2"	14"	16"	16"	16"	16"	16"	16"	16"	18"	18"	18"	18"
	5-1/4"	14"	14"	14"	14"	14"	14"	14"	14"	16"	16"	16"	16"
18'-6"	3-1/2"	16"	16"	16"	16"	16"	18"	18"	-	-	-	-	-
	5-1/4"	14"	14"	14"	14"	14"	14"	16"	16"	16"	16"	16"	16"
20'-0"	3-1/2"	16"	16"	18"	18"	18"	18"	18"	18"	-	-	-	-
	5-1/4"	14"	14"	16"	16"	16"	16"	16"	16"	16"	16"	18"	18"
22'-0"	3-1/2"	18"	18"	18"	-	-	-	-	-	-	-	-	-
	5-1/4"	16"	16"	16"	16"	16"	18"	18"	18"	18"	18"	18"	-
24'-0"	3-1/2"	-	-	-	-	-	-	-	-	-	-	-	-
	5-1/4"	18"	18"	18"	18"	18"	-	-	-	-	-	-	-

Span	Beam Width	Span Carried By Beam											
		20'	22'	24'	26'	28'	30'	32'	34'	36'	38'	40'	
6'-0"	3-1/2"	7-1/4"	7-1/4"	7-1/4"	7-1/4"	7-1/4"	7-1/4"	7-1/4"	7-1/4"	7-1/4"	7-1/4"	7-1/4"	7-1/4"
	5-1/4"	7-1/4"	7-1/4"	7-1/4"	7-1/4"	7-1/4"	7-1/4"	7-1/4"	7-1/4"	7-1/4"	7-1/4"	7-1/4"	7-1/4"
8'-0"	3-1/2"	7-1/4"	7-1/4"	7-1/4"	9-1/4"	9-1/4"	9-1/4"	9-1/4"	9-1/4"	9-1/4"	9-1/4"	9-1/4"	9-1/4"
	5-1/4"	7-1/4"	7-1/4"	7-1/4"	7-1/4"	7-1/4"	7-1/4"	7-1/4"	7-1/4"	7-1/4"	7-1/4"	7-1/4"	7-1/4"
9'-6"	3-1/2"	9-1/4"	9-1/4"	9-1/4"	9-1/4"	9-1/4"	9-1/4"	9-1/4"	9-1/4"	9-1/2"	11-1/4"	11-1/4"	11-1/4"
	5-1/4"	7-1/4"	7-1/4"	7-1/4"	9-1/4"	9-1/4"	9-1/4"	9-1/4"	9-1/4"	9-1/4"	9-1/4"	9-1/4"	9-1/4"
10'-0"	3-1/2"	9-1/4"	9-1/4"	9-1/4"	9-1/4"	9-1/2"	11-1/4"	11-1/4"	11-1/4"	11-1/4"	11-1/4"	11-1/4"	11-1/4"
	5-1/4"	9-1/4"	9-1/4"	9-1/4"	9-1/4"	9-1/4"	9-1/4"	9-1/4"	9-1/4"	9-1/4"	9-1/4"	9-1/4"	9-1/4"
12'-0"	3-1/2"	11-1/4"	11-1/4"	11-1/4"	11-1/4"	11-1/4"	11-7/8"	11-7/8"	14"	14"	14"	14"	14"
	5-1/4"	9-1/4"	9-1/4"	9-1/2"	9-1/2"	11-1/4"	11-1/4"	11-1/4"	11-1/4"	11-1/4"	11-1/4"	11-1/4"	11-1/4"
14'-0"	3-1/2"	11-7/8"	14"	14"	14"	14"	14"	14"	14"	16"	16"	16"	16"
	5-1/4"	11-1/4"	11-1/4"	11-1/4"	11-1/4"	11-7/8"	11-7/8"	11-7/8"	14"	14"	14"	14"	14"
16'-0"	3-1/2"	14"	14"	14"	16"	16"	16"	16"	16"	16"	18"	18"	18"
	5-1/4"	11-7/8"	14"	14"	14"	14"	14"	14"	14"	14"	14"	16"	16"
16'-6"	3-1/2"	14"	16"	16"	16"	16"	16"	-	-	-	-	-	-
	5-1/4"	14"	14"	14"	14"	14"	14"	14"	14"	16"	16"	16"	16"
18'-0"	3-1/2"	16"	16"	18"	18"	18"	18"	18"	18"	18"	18"	18"	18"
	5-1/4"	14"	14"	14"	16"	16"	16"	16"	16"	16"	16"	18"	18"
18'-6"	3-1/2"	16"	18"	18"	18"	18"	-	-	-	-	-	-	-
	5-1/4"	14"	14"	16"	16"	16"	16"	16"	16"	18"	18"	18"	18"
20'-0"	3-1/2"	18"	18"	18"	-	-	-	-	-	-	-	-	-
	5-1/4"	16"	16"	16"	16"	18"	18"	18"	18"	18"	18"	18"	-
22'-0"	3-1/2"	-	-	-	-	-	-	-	-	-	-	-	-
	5-1/4"	18"	18"	18"	18"	18"	-	-	-	-	-	-	-
24'-0"	3-1/2"	-	-	-	-	-	-	-	-	-	-	-	-
	5-1/4"	18"	-	-	-	-	-	-	-	-	-	-	-

**NOTES:**

1. Span is center-to-center of supports and is valid for simple beam spans only.
2. End supports require 3" bearing except 4-1/2" is required where **bold**. The end supports for the standard garage door spans of 9'-6", 16'-6" and 18'-6" have been limited to 3" (two trimmers) on each end. The bearing length is based on the compression strength, perpendicular-to-grain, of the LVL. See the Reaction Capacity table on page 4 for additional information.
3. Deflections are limited to L/360 live or snow load and L/240 total load.
4. Loads assume a 2' maximum overhang on the roof.
5. Beam width can be either a single piece of LVL or built up from multiple plies that are nailed, bolted or connected with other approved fasteners. Refer to pages 14-15 for connection details.
6. Do not use where marked "-".

# LVL 2.0E Uniform Floor Load (PLF) Tables

## TO USE:

1. Select the required Span.
2. Divide the design loads by the desired number of plies to verify each ply of the beam.
3. Select a beam that exceeds the Total Load and the appropriate Live Load.
4. Check the bearing requirements.

## EXAMPLE:

For a 16'-6" span, select a 2- and 3-ply beam that satisfies an L/360 Live Load deflection limit for the following design loads: Live Load = 440 plf, Total Load = 605 plf

## SOLUTION FOR A 2-PLY BEAM:

Design Total Load per ply =  $605 / 2 = 303$  plf  
 Design Live Load per ply =  $440 / 2 = 220$  plf

**Use 2 plies 1-3/4" x 14"**

(Total Load = 360 plf, Live Load L/360 = 245 plf)

## SOLUTION FOR A 3-PLY BEAM:

Design Total Load per ply =  $605 / 3 = 202$  plf  
 Design Live Load per ply =  $440 / 3 = 147$  plf

**Use 3 plies 1-3/4" x 11-7/8"**

(Total Load = 223 plf, Live Load L/360 = 152 plf)

Span	1-3/4" x 7-1/4"			1-3/4" x 9-1/4"			1-3/4" x 9-1/2"			1-3/4" x 11-1/4"			Span
	Live Load		Total Load	Live Load		Total Load	Live Load		Total Load	Live Load		Total Load	
	L/480	L/360		L/480	L/360		L/480	L/360		L/480	L/360		
5'			767			979			1006			1191	5'
6'	494		639			815			837			991	6'
7'	323	430	547	630		698	677		717			849	7'
8'	221	295	439	438	584	610	471		626			742	8'
9'	158	211	313	316	421	542	340	454	556	542		659	9'
9'-6"	135	180	267	271	362	513	292	390	527	468		624	9'-6"
10'	116	155	230	235	313	465	253	337	500	406	542	592	10'
11'	88	118	173	179	238	353	193	257	381	311	415	538	11'
12'	68	91	133	139	186	274	150	200	296	244	325	482	12'
13'	54	72	105	110	147	216	119	159	234	194	259	383	13'
14'	43	58	83	89	119	173	96	128	188	157	209	309	14'
15'	35	47	67	73	97	141	78	105	153	128	171	252	15'
16'	-	-	-	60	80	116	65	87	125	107	142	208	16'
16'-6"	-	-	-	55	73	105	59	79	114	97	130	190	16'-6"
17'	-	-	-	50	67	96	54	72	104	89	119	173	17'
18'	-	-	-	42	57	80	46	61	87	75	101	146	18'
18'-6"	-	-	-	39	52	74	42	56	80	70	93	134	18'-6"
19'	-	-	-	36	48	68	39	52	74	64	86	124	19'
20'	-	-	-	31	41	58	33	45	63	55	74	105	20'
21'	-	-	-	-	-	-	-	-	-	48	64	91	21'
22'	-	-	-	-	-	-	-	-	-	42	56	78	22'

Span	1-3/4" x 11-7/8"			1-3/4" x 14"			1-3/4" x 16"			1-3/4" x 18"			Span
	Live Load		Total Load	Live Load		Total Load	Live Load		Total Load	Live Load		Total Load	
	L/480	L/360		L/480	L/360		L/480	L/360		L/480	L/360		
5'			1257			1482			1694			1906	5'
6'			1046			1234			1410			1586	6'
7'			896			1056			1207			1358	7'
8'			783			923			1055			1187	8'
9'	627		695			820			937			1054	9'
9'-6"	542		659			776			887			998	9'-6"
10'	471		625	735		737			843			948	10'
11'	362	483	568	569		670			765			861	11'
12'	284	379	520	449	599	613	645		701			788	12'
13'	226	302	447	360	480	565	520		646	714		727	13'
14'	183	244	361	292	390	524	424	566	599	585		674	14'
15'	150	200	295	241	321	473	350	467	559	485		629	15'
16'	125	166	244	200	267	394	292	390	523	406	542	589	16'
16'-6"	114	152	223	183	245	360	268	358	500	373	497	571	16'-6"
17'	104	139	204	168	225	330	246	329	471	343	458	554	17'
18'	88	118	171	143	190	279	209	279	411	292	390	522	18'
18'-6"	82	109	158	132	176	257	194	258	380	271	361	494	18'-6"
19'	75	101	145	122	163	238	179	239	351	251	335	468	19'
20'	65	87	124	105	140	204	155	207	302	217	289	422	20'
21'	56	75	107	91	122	176	134	179	261	189	252	369	21'
22'	49	65	92	80	106	153	118	157	227	165	220	322	22'
23'	43	57	80	70	93	133	103	138	199	145	194	282	23'
24'	38	51	70	62	82	117	91	122	175	128	171	248	24'
25'	33	45	61	55	73	103	81	108	154	114	152	220	25'
26'	30	40	54	49	65	91	72	96	137	102	136	195	26'
27'	-	-	-	43	58	80	65	86	121	91	122	174	27'
28'	-	-	-	39	52	71	58	77	108	82	109	155	28'
29'	-	-	-	35	47	64	52	70	97	74	99	139	29'
30'	-	-	-	32	42	57	47	63	87	67	89	125	30'

## DESIGN ASSUMPTIONS:

1. Span is the center-to-center distance of the supports and is valid for simple or equal, continuous span applications.
2. The values in the tables are for uniform loads only.
3. Total Load is for normal (100%) duration and has been adjusted to account for the self-weight of the member.
4. Live Load deflection has been limited to L/360 or L/480 as noted in the table.
5. Total deflection has been limited to L/240. Long term deflection (creep) has not been considered.
6. These tables assume full lateral support of the compression edge. Full support is considered to be a maximum unbraced length of 24'.
7. Proper bearing must be provided. Bearing length must be checked for support reactions with the table on page 4.

## ADDITIONAL NOTES:

1. The allowable loads represent the capacity of the member in pounds per linear foot (plf) of length.
2. The designer shall check both the Total Load and the appropriate Live Load column.
3. Where the Live Load is blank, the Total Load governs the design.
4. Depths of 16" and greater shall be used with a minimum of two plies unless designed specifically as a single ply with proper lateral bracing, such as a marriage beam for each half of a manufactured home before the units are joined.
5. The allowable loads in the table are for a single ply of LVL. Multiply the values by the number of plies of equal thickness to size a built-up member or divide the required loads by the number of equal thickness plies to directly verify the capacity of each individual ply. Example: double the allowable loads in the table for a 2-ply member or divide the required uniform loads by 2 to verify each ply of a 2-ply member.
6. The member width shall be properly built up by connecting plies of the same grade of LVL. Refer to the multiple-ply connections on pages 14-15.
7. Do not use a product where designated "-" without further analysis by a design professional.

## ACTUAL DEFLECTION BASED ON SPAN AND LIMIT

Span (ft)	10'	12'	14'	16'	18'	20'	22'	24'	26'	28'	30'
L/480	1/4"	5/16"	3/8"	3/8"	7/16"	1/2"	9/16"	5/8"	5/8"	11/16"	3/4"
L/360	5/16"	3/8"	7/16"	9/16"	5/8"	11/16"	3/4"	13/16"	7/8"	15/16"	1"
L/240	1/2"	5/8"	11/16"	13/16"	7/8"	1"	1-1/8"	1-3/16"	1-5/16"	1-3/8"	1-1/2"

# LVL 2.OE Uniform Roof Load (PLF) Tables

## TO USE:

1. Select the required Span. For beams with a pitch greater than 1:12, multiply the horizontal span by the slope adjustment factor from the table below.
2. Divide the design loads by the desired number of plies to verify each ply of the beam.
3. Select a beam that exceeds the appropriate Total Load (Snow 115% or Non-Snow 125%) and the appropriate Snow/Live Load (L/360 or L/240).
4. Check the bearing requirements.

## EXAMPLE:

For a 16' horizontal span with a pitch of 4:12, select a 2- and 3-ply beam that satisfies an L/360 Snow Load deflection limit for the following design loads: Snow Load = 720 plf, Total Load = 1128 plf

**CALCULATE BEAM SPAN:** 16' x 1.054 = 16.9' → Use Span = 17'

## SOLUTION FOR A 2-PLY BEAM:

Design Total Load per ply = 1128 / 2 = 564 plf

Design Snow Load per ply = 720 / 2 = 360 plf

Use 2 plies 1-3/4" x 18"

(Total Load = 638 plf, Snow Load L/360 = 458 plf)

## SOLUTION FOR A 3-PLY BEAM:

Design Total Load per ply = 1128 / 3 = 376 plf

Design Snow Load per ply = 720 / 3 = 240 plf

Use 3 plies 1-3/4" x 16"

(Total Load = 543 plf, Snow Load L/360 = 329 plf)

Span	1-3/4" x 7-1/4"				1-3/4" x 9-1/4"				1-3/4" x 9-1/2"				1-3/4" x 11-1/4"				Span		
	Snow/Live Load		Total Load		Snow/Live Load		Total Load		Snow/Live Load		Total Load		Snow/Live Load		Total Load				
	L/360	L/240	Snow 115%	Non-Snow 125%	L/360	L/240	Snow 115%	Non-Snow 125%	L/360	L/240	Snow 115%	Non-Snow 125%	L/360	L/240	Snow 115%	Non-Snow 125%			
5'			883	960			1127	1225			1157	1258			1370	1490	5'		
6'	659		735	799			938	1020			963	1048			1141	1241	6'		
7'	430	646	630	685	840		803	874			825	897			977	1063	7'		
8'	295	443	550	587	584		702	764	628			721	784			854	929	8'	
9'	211	316	418	418	421	632	624	678	454	681			641	697	723		759	825	9'
9'-6"	180	271	358	358	362	543	591	642	390	585			607	660	624		718	781	9'-6"
10'	155	233	308	308	313	470	561	610	337	506			576	626	542		682	742	10'
11'	118	177	232	232	238	358	467	473	257	386			491	510	415	623	620	674	11'
12'	91	137	179	179	186	279	367	367	200	301			397	397	325	488	567	617	12'
13'	72	108	141	141	147	221	290	290	159	239			314	314	259	388	483	513	13'
14'	58	87	113	113	119	178	233	233	128	193			252	252	209	314	413	413	14'
15'	47	71	91	91	97	146	190	190	105	157			205	205	171	257	338	338	15'
16'	39	59	75	75	80	120	156	156	87	130			169	169	142	214	279	279	16'
16'-6"	35	53	68	68	73	110	142	142	79	119			154	154	130	195	255	255	16'-6"
17'	32	49	62	62	67	101	130	130	72	109			141	141	119	179	233	233	17'
18'	-	-	-	-	57	85	109	109	61	92			118	118	101	151	196	196	18'
18'-6"	-	-	-	-	52	78	100	100	56	85			109	109	93	140	181	181	18'-6"
19'	-	-	-	-	48	72	92	92	52	78			100	100	86	129	167	167	19'
20'	-	-	-	-	41	62	78	78	45	67			85	85	74	111	143	143	20'
21'	-	-	-	-	36	54	67	67	39	58			73	73	64	96	123	123	21'
22'	-	-	-	-	31	47	58	58	34	51			63	63	56	84	106	106	22'

Span	1-3/4" x 11-7/8"				1-3/4" x 14"				1-3/4" x 16"				1-3/4" x 18"				Span		
	Snow/Live Load		Total Load		Snow/Live Load		Total Load		Snow/Live Load		Total Load		Snow/Live Load		Total Load				
	L/360	L/240	Snow 115%	Non-Snow 125%	L/360	L/240	Snow 115%	Non-Snow 125%	L/360	L/240	Snow 115%	Non-Snow 125%	L/360	L/240	Snow 115%	Non-Snow 125%			
5'			1447	1573			1706	1854			1949	2119			2193	2281	5'		
6'			1204	1310			1420	1544			1623	1765			1826	1929	6'		
7'			1031	1122			1216	1322			1390	1511			1564	1670	7'		
8'			902	981			1063	1156			1215	1321			1367	1487	8'		
9'	837		801	871			944	1027			1079	1174			1214	1320	9'		
9'-6"	723		758	825			894	972			1022	1111			1150	1250	9'-6"		
10'	628		720	783			849	923			970	1055			1092	1187	10'		
11'	483		654	711	759		771	839			881	959			992	1079	11'		
12'	379	568	599	652	599		706	768	860			807	878			908	988	12'	
13'	302	453	535	582	480		651	709	693			744	810			838	911	13'	
14'	244	367	461	483	390	585	604	657	566			691	751	780		777	845	14'	
15'	200	301	395	395	321	482	545	593	467			644	701	647		725	788	15'	
16'	166	250	327	327	267	401	478	520	390	585			603	656	542		679	739	16'
16'-6"	152	228	299	299	245	367	449	483	358	537			577	628	497		658	716	16'-6"
17'	139	209	274	274	225	337	423	443	329	493			543	591	458	687	638	695	17'
18'	118	177	231	231	190	286	374	374	279	419			483	526	390	585	602	655	18'
18'-6"	109	164	212	212	176	264	345	345	258	388			457	497	361	542	570	620	18'-6"
19'	101	151	196	196	163	245	319	319	239	359			433	471	335	502	540	588	19'
20'	87	130	168	168	140	211	274	274	207	310			390	406	289	434	486	529	20'
21'	75	113	145	145	122	183	237	237	179	269			351	351	252	378	440	479	21'
22'	65	98	125	125	106	160	206	206	157	236			306	306	220	331	400	432	22'
23'	57	86	109	109	93	140	180	180	138	207			268	268	194	291	365	379	23'
24'	51	76	96	96	82	124	158	158	122	183			236	236	171	257	334	334	24'
25'	45	67	84	84	73	110	139	139	108	162			209	209	152	229	296	296	25'
26'	40	60	74	74	65	98	123	123	96	145			185	185	136	204	263	263	26'
27'	36	54	66	66	58	87	110	110	86	130			165	165	122	183	235	235	27'
28'	32	48	58	58	52	78	98	98	77	116			147	147	109	164	210	210	28'
29'	-	-	-	-	47	71	87	87	70	105			132	132	99	148	189	189	29'
30'	-	-	-	-	42	64	78	78	63	95			119	119	89	134	170	170	30'

## DESIGN ASSUMPTIONS:

1. Span is the center-to-center distance of the supports, along the sloped length of the member and is valid for simple or equal, continuous span applications.
2. The values in the tables are for uniform loads only.
3. Total Load is for Snow (115%) or Non-Snow (125%) duration, as noted in the table, and has been adjusted to account for the self-weight of the member.
4. Snow/Live Load deflection has been limited to L/360 or L/240 as noted in the table. To design for a Snow or Roof Live Load deflection of L/480, use the Uniform Floor Load tables on page 10.
5. Total deflection has been limited to L/180. Long term deflection (creep) has not been considered.
6. These tables assume full lateral support of the compression edge. Full support is considered to be a maximum unbraced length of 24'.
7. Proper bearing must be provided. Bearing length must be checked for support reactions with the table on page 4.

## ADDITIONAL NOTES:

1. The allowable loads represent the capacity of the member in pounds per lineal foot (plf) of length.
2. The designer shall check both the appropriate Total Load and the appropriate Live Load column.
3. For roofs with a slope of 2:12 or greater, the horizontal span shall be multiplied by the appropriate slope adjustment factor from the table below.
4. Where the Live Load is blank, the Total Load governs the design.
5. Depths of 16" and greater shall be used with a minimum of two plies unless designed specifically as a single ply with proper lateral bracing, such as a marriage beam for each half of a manufactured home before the units are joined.
6. The allowable loads in the table are for a single ply of LVL. Multiply the values by the number of plies of equal thickness to size a built-up member or divide the required loads by the number of equal thickness plies to directly verify the capacity of each individual ply. Example: double the allowable loads in the table for a 2-ply member or divide the required uniform loads by 2 to verify each ply of a 2-ply member.
7. The member width shall be properly built up by connecting plies of the same grade of LVL. Refer to the multiple-ply connections on pages 14-15.
8. Do not use a product where designated "-" without further analysis by a design professional.

SLOPE ADJUSTMENT FACTOR																
Slope	2:12	3:12	4:12	5:12	6:12	7:12	8:12	9:12	10:12	11:12	12:12					
Factor	1.014	1.031	1.055	1.084	1.119	1.158	1.202	1.250	1.302	1.357	1.415					

# Temporary Bracing & Warnings

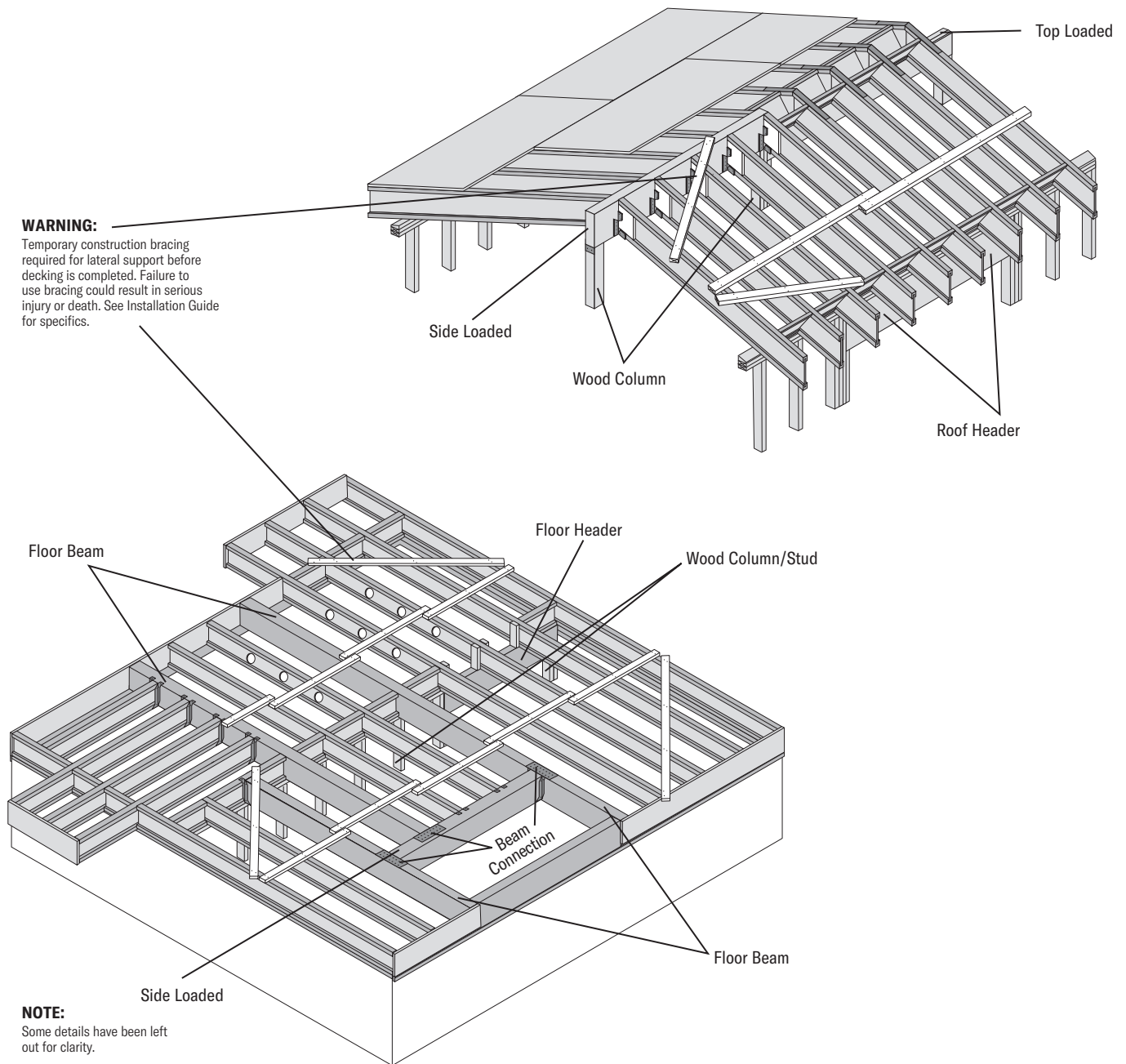

## WARNING

**DON'T USE VISUALLY DAMAGED PRODUCTS WITHOUT FIRST CHECKING WITH YOUR LOCAL LP® SOLIDSTART® ENGINEERED WOOD PRODUCTS DISTRIBUTOR OR SALES OFFICE. (SEE BACK COVER FOR DETAILS.)**

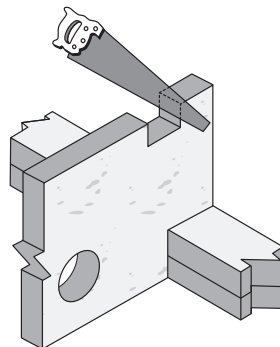

**DON'T BORE HOLES OR NOTCH UNLESS REVIEWED BY A DESIGN PROFESSIONAL. EXCEPTION: SMALL HOLES MAY BE DRILLED IN ACCORDANCE WITH THE BEAM HOLE DETAILS ON PAGE 13.**

**P3 BEAM CONNECTION**

Structurally adequate hanger

Hanger shall apply load equally to each ply or special design required

**P4 STEEL COLUMN & WOOD COLUMN**

Framing details such as joists and sheathing shall be provided to prevent beam from twisting or rotating at support

Simpson® CCO, USP® CCS or equal column cap

Provide specified bearing length

Simpson PC or CC, USP PCM or CC or equal post or column cap

Provide specified bearing length

**P6 FLOOR BEAM (Flush ceiling)**

Top mount hangers recommended

Check stiffener/filler requirements depending on load and hanger type

Prevent the beam from rotating by using rim or blocking

**P7 CONCRETE WALL**

**NOTE:** Protect wood from contact with concrete as required by code

Simpson GLB, USP LBS or equal seat

**Q1 WINDOW/DOOR HEADER**

Rim Board

Provide specified or prescriptive bearing length

**Q2 WINDOW/DOOR HEADER**

Continuous plate

Provide specified or prescriptive bearing length

**BEAM HOLE DETAILS**

1 foot

Minimum 2 x diameter of larger hole

1 foot

1/3 beam depth

Area B

Area A

Area B

1/3 span length

Clear span

**Q4 MASONRY HANGER**

Simpson WM, USP MPH, or equal hanger

**NOTE:** Protect wood from contact with concrete as required by code

**NOTES:**

1. These guidelines apply to uniformly loaded beams selected from the Quick Reference Tables or the Uniform Load Tables or designed with LP's design/specification software only. For all other applications, such as beams with concentrated loads, please contact your LP® SolidStart® Engineered Wood Products distributor for assistance.
2. Round holes can be drilled anywhere in "Area A" provided that: no more than four holes are cut, with the minimum spacing described in the diagram. The maximum hole size is 1-1/2" for depths up to 9-1/4", and 2" for depths greater than 9-1/4".
3. Rectangular holes are NOT allowed.
4. DO NOT drill holes in cantilevers without prior approval from the project designer.
5. Other hole sizes and configurations MAY be possible with further engineering analysis. For more information, contact your LP SolidStart Engineered Wood Products distributor.
6. Up to three 3/4" holes may be drilled in "Area B" to accommodate wiring and/or water lines. These holes shall be at least 12" apart. The holes shall be located in the middle third of the depth, or a minimum of 3" from the bottom and top of the beam. For beams shallower than 9-1/4", locate holes at mid-depth.
7. Protect plumbing holes from moisture.

# Connection Details

**P1 TOP-LOADED BEAM – NAILED CONNECTION**  
(See Connection Assemblies for more details)

**P2 TOP-LOADED BEAM – BOLTED CONNECTION**  
(See Connection Assemblies for more details)

**Q3 SIDE-LOADED BEAM**  
(See Connection Assemblies for more details)

DETAIL A	DETAIL B	DETAIL C/E	DETAIL D	DETAIL F	DETAIL G	DETAIL H
<b>MAXIMUM 4" WIDE 2-PLY BEAMS</b>  2" max. ply thickness	<b>MAXIMUM 6" WIDE 3-PLY BEAMS</b>  2" max. ply thickness	<b>MAXIMUM 7-1/4" WIDE 2-PLY BEAMS</b>  2" maximum side member 3-1/2" main member for C 5-1/4" main member for E	<b>MAXIMUM 9-1/4" WIDE 3-PLY BEAMS</b>  2" maximum side members 5-1/4" maximum main member	<b>MAXIMUM 7" WIDE 3- OR 4-PLY BEAMS</b>  3"	<b>MAXIMUM 7" WIDE 2-PLY BEAMS</b>  3"	<b>MAXIMUM 7" WIDE 2-, 3- OR 4-PLY BEAMS</b>  2" Simpson SDS 1/4" x 6" Simpson SDW 6-3/4" or equal Simpson SDW may be driven from one side.

\* Minimum of 2" or the screw mfg.'s edge distance.

UNIFORM SIDE-LOAD CAPACITY (PLF)				
Connection Detail	2 Rows of Nails at 12" oc	3 Rows of Nails at 12" oc	2 Rows of 1/2" Bolts at 24" oc	2 Rows of 1/2" Bolts at 12" oc
A	412	618	506	1012
B	309	464	380	760
C	309	464	522	1044
D	275	412	464	928
E	275	412	464	928
F	na	na	337	674
G	na	na	858	1716
H	Refer to the screw manufacturer's catalog for installation requirements & capacities.			

NAIL SCHEDULE				
Nail Length (in)	Nail Diameter (in)	Lateral Load Capacity (lbs)	Nail Size Factor	Nail Type
3-1/2"	0.162	141	1.37	16d common
	0.135	103	1.00	16d box
3-1/4"	0.148	118	1.15	16d sinker/12d common
	0.128	93	0.90	12d box
3"	0.120	81	0.79	Power-driven nail <sup>13</sup>
	0.148	99	0.96	10d common
	0.128	91	0.88	10d box
	0.120	81	0.79	Power-driven nail <sup>13</sup>

## NOTES:

- The Uniform Side-Load Capacity values are the maximum load that can be applied to either side of the beam, based on the selected connection detail, and represent loads applied uniformly such as joists supported by hangers spaced 24" oc or less. Connections for discrete point loads may be determined with this table by calculating the equivalent fastener schedule within a 2' length centered about the point load. Details **B** and **D** shall have the back ply connected with a number of nails equal to half that used to connect the front ply - see the Side-Load Connection Example and detail on page 15. All nail and bolt spacing requirements shall be verified. The full length of the beam shall be connected with the standard connection or with the appropriate uniform side-load connection from this table. The beam shall be designed to support all applied loads.
- Values are for normal load duration and shall be adjusted according to code.
- The values for Uniform Side-Load Capacity for nails and Lateral Load Capacity (from Nail Schedule) are based on Douglas Fir lumber equivalence (SG = 0.50) for a 16d box (3-1/2" x 0.135"Ø) nails for 1-3/4" LVL. For other nail sizes, multiply the Uniform Side-Load Capacity by the Nail Size Factor from the Nail Schedule. For 1-1/2" LVL, multiply by the Nail Size Factor for the appropriate 3" nail. Higher capacities may be calculated using the equivalent specific gravities tabulated in the Fastener Design table on page 15.
- The values for the Uniform Side-Load Capacity for bolts are based on Douglas Fir lumber equivalence (SG = 0.50) for ASTM grade A-307, 1/2"Ø bolts, for loads applied perpendicular-to-grain. For 1-1/2" LVL, multiply these values by 0.86 or calculate for the needed detail. Higher bolt capacities may be calculated using the equivalent specific gravities tabulated in the Fastener Design table on page 15.
- For nails at 8" oc, multiply the capacity by 1.5. For nails at 6" oc, multiply the capacity by 2. For four rows of nails, double the two-row capacity.
- Use 2 rows of nails for depths to 12'. Use 3 rows of nails for depths greater than 12', up to 18'.
- Unless specifically designed, use 3-1/2" nails for 1-3/4" and 2" thick plies and use 3" nails for 1-1/2" thick plies. If the nails do not fully penetrate the second ply (main member), then the nails shall be driven from both faces.
- For detail **A**, or when attaching the first two plies for detail **B** (and optionally for details **F** and **H** - see note 11), the nails may be driven all from one face or alternating from both faces. If the nails do not fully penetrate the second ply, then the nails shall be driven from both faces.
- When driving nails from each face, alternate every other nail in each row.
- For details **C** and **E**, when side-loaded, the larger side-load shall be applied to the thicker ply (main member).
- For details **F** and **H**, it is permissible to nail the plies together before bolting or driving Simpson SDS or SDW (or equal) screws. Nail two plies together (see note 8) then nail one additional ply to each side.
- Beams wider than 5-1/2" shall be top-loaded or side-loaded from both sides to prevent rotation. For side loads applied to one side of a beam only, the project designer shall verify torsional capacity or detail the beam to prevent rotation due to any side loads. Consult a design professional for other options.
- Power-driven nails shall conform to ICC-ES report ESR-1539 (International Staple, Nail and Tool Association) for power-driven staples and nails.
- Other nail, screw or bolt configurations are possible. Refer to the Fastener Design table on page 15 or contact your LP® SolidStart® Engineered Wood Products distributor.

## FASTENER DESIGN

Equivalent Specific Gravity					
Nails Only		Nails and Wood Screws		Bolts and Lag Screws	
Withdrawal		Dowel Bearing (into the face only)			
Edge	Face	Edge	Face	Load Applied Parallel to Grain	Load Applied Perpendicular to Grain
0.46	0.50	0.50	0.50	0.46	0.50

### NOTES:

- The equivalent specific gravity for each connection type listed above is for normal load duration and shall be adjusted according to code.
- Fastener spacing, end and edge distance shall be as specified by code except for nail spacing as specified below.
- See details to right for fastener and applied load orientation.

## FASTENER & LOAD ORIENTATION

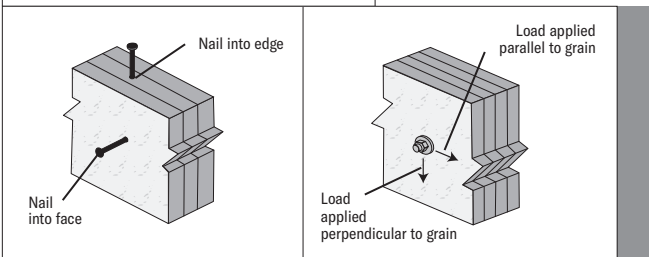

## NAIL SPACING REQUIREMENTS

LVL Ply Thickness	Fastener Orientation	Common Nail Size	Minimum End Distance	Minimum Nail Spacing per Row	
				Single Row	Multiple Rows
≥ 1-1/2"	Edge <sup>7</sup>	8d & smaller	2-1/2"	3"	4"
		10d & 12d	2-1/2"	4"	5"
		16d <sup>5</sup>	3-1/2"	5"	6"
	Face <sup>8</sup>	8d & smaller	1-1/2"	3"	3"
		10d & 12d	1-1/2"	3"	3"
		16d <sup>5</sup>	1-1/2"	5"	5"

### NOTES:

- Edge distance shall be sufficient to prevent splitting.
- Multiple rows of nails shall be offset at least 1/2" and staggered, and equally spaced about the centerline of the edge or face (whichever applies).
- Edge orientation refers to nails driven into the narrow edge; parallel to the face of the strands for LP LVL. Face orientation refers to nails driven into the wide face; perpendicular to the face of the strands for LP LVL.
- Nails listed are common wire nails.
- 16d sinkers (3-1/4" x 0.148") may be spaced the same as a 10d and 12d common nail.
- The minimum nail spacing may be reduced by 1" for LP LVL stamped with plant numbers 1066 and 1071. The minimum nail spacing may be reduced by 1" for LP LVL stamped with plant number 1089 provided that the thickness is 1-3/4" or greater.
- Nail penetration for edge nailing must not exceed 2" for 16d common nails (3-1/2" by 0.162" diameter) and 2-1/2" for all nails with a smaller shank diameter.
- Minimum nail spacing for the face orientation is applicable to nails that are installed in rows that are parallel to the direction of the face grain (length) of the LP LVL. For nails driven into the face in rows that are perpendicular to the direction of the grain (thickness/depth) of the LP LVL, the minimum nail spacing must be sufficient to prevent splitting of the wood.

## SIDE-LOAD CONNECTION EXAMPLE

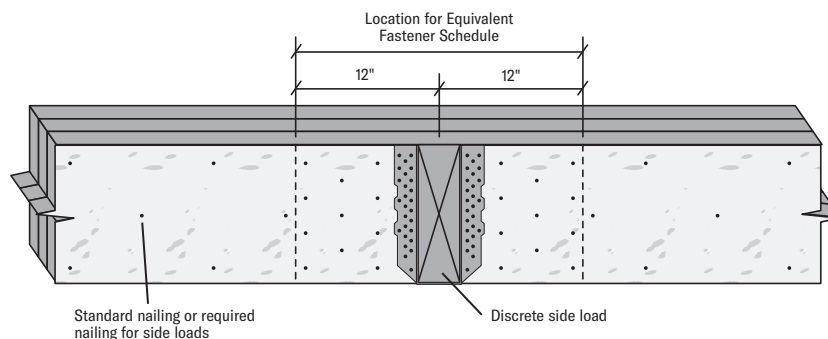

**EXAMPLE:** Assuming a properly designed 3-ply 14" beam, determine the equivalent connection to support a 3300 lb point load applied to the side of the beam.

### SOLUTION:

- Determine the equivalent PLF load over the 2' length by dividing the applied load by 2: 3300 lb / 2' = 1650 plf
- Divide the equivalent PLF load by the capacity for the appropriate detail. For a 14" depth, 3 rows of nails are required. For Detail B with 3 rows of nails at 12" oc: 1650 plf / 464 plf = 3.6
- The required total number of nails is: 3.6 \* 3 rows of nails @ 12" oc = 10.8 nails per foot
- Connect the front (loaded) ply with the nailing determined in step 3: drive 11 16d box nails within 12" to each side of the point load (a total of 22 nails). Verify nail spacing.
- Connect the back ply with half the number of nails determined in step 4: drive 6 16d box nails, from the back, within 12" to each side of the point load (a total of 12 nails). Verify nail spacing.
- Connect full length of member with the standard nailing or as required for side loads.
- Project designer shall detail to prevent rotation of the beam due to the applied side load.

# HANDLING & STORAGE GUIDELINES

- **WARNING:** Failure to follow proper procedures for handling, storage and installation could result in unsatisfactory performance, unsafe structures and possible collapse.
- Keep LP® SolidStart® Engineered Wood Products dry. These products are intended to resist the effects of moisture on structural performance from normal construction delays but are not intended for permanent exposure to the weather.
- Unload products carefully, by lifting. Support the bundles to reduce excessive bowing. Individual products should be handled in a manner which prevents physical damage during measuring, cutting, erection, etc. I-Joists shall be handled vertically and not flatwise.
- Keep products stored in wrapped and strapped bundles, stacked no more than 10' high. Support and separate bundles with 2 x 4 (or larger) stickers spaced no more than 10' apart. Keep stickers in line vertically.
- Product must not be stored in contact with the ground, or have prolonged exposure to the weather.
- Use forklifts and cranes carefully to avoid damaging product.
- Do not use a visually damaged product. Call your local LP SolidStart Engineered Wood Products distributor for assistance when damaged products are encountered.
- For satisfactory performance, LP SolidStart Engineered Wood Products must be used under dry, covered and well-ventilated interior conditions in which the equivalent moisture content in lumber will not exceed 16%.
- For built-up members, LP SolidStart I-Joists, LSL and LVL shall be dry before nailing or bolting to avoid trapping moisture.
- LP SolidStart I-Joists, LSL and LVL shall not be used for unintended purposes such as ramps and planks.

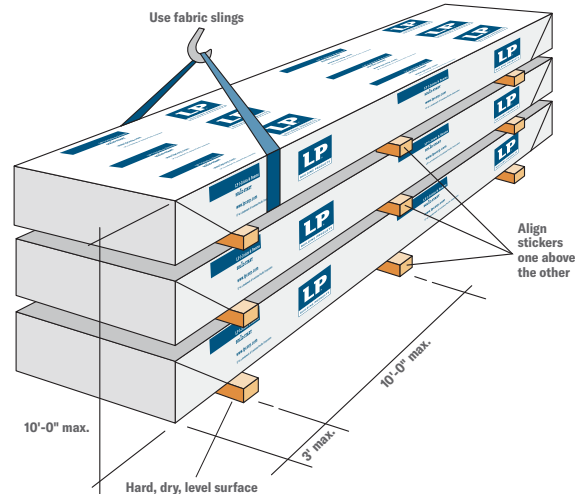

## LP SolidStart LVL 2.0E

Standard Thickness of 1-3/4" and 3-1/2" (also available in 1-1/2")

Billet thicknesses of 5-1/4" and 7"

Standard Depths of 7-1/4", 9-1/4", 9-1/2", 11-1/4", 11-7/8", 14", 16", 18", 20", and 24"

Lengths up to 60'

Specific sizes may not be available in all locations, contact your local distributor for availability.

A water-resistant coating called SiteCote™ is applied to LP LVL for extra weather protection during construction.

## CODE EVALUATION

Code evaluation reports can be obtained at [www.lpcorp.com](http://www.lpcorp.com)

ICC ESR 2403

APA® PR-L280

Florida FL15228

LA City RR-25783

For more information on the full line of LP SolidStart Engineered Wood Products or the nearest distributor, visit our web site at [LPCorp.com](http://LPCorp.com).

Phone: 1-888-820-0325

E-mail: [customer.support@LPCorp.com](mailto:customer.support@LPCorp.com).

LP SolidStart Engineered Wood Products are manufactured at different locations in the United States and Canada.



Good for you. Good for our forests.  
[www.sfi-program.org](http://www.sfi-program.org)

BV-SFICOC-US09000262



PEFC/29-31-102



**For product catalog & complete warranty details, visit [LPCorp.com](http://LPCorp.com)**

### Cal. Prop 65 Warning:



**WARNING:** Drilling, sawing, sanding or machining wood products can expose you to wood dust, a substance known to the State of California to cause cancer. Avoid inhaling wood dust or use a dust mask or other safeguards for personal protection. For more information go to [www.P65Warnings.ca.gov/wood](http://www.P65Warnings.ca.gov/wood).

© 2019 Louisiana-Pacific Corporation. All rights reserved. APA, APA Rated, and APA Product Report are registered trademarks of APA – The Engineered Wood Association. SIMPSON Strong-Tie® is a registered trademark of Simpson Strong-Tie Company, Inc. USP® is a registered trademark of MiTek Holdings, Inc. SFI and the associated logo are trademarks of Sustainable Forestry Initiative, Inc. PEFC and the associated logo are trademarks of Programme for the Endorsement of Forest Certification. LP® and SolidStart® are registered trademarks of Louisiana-Pacific Corporation. Printed in USA. Specifications (details) subject to change without notice.

NOTE: Louisiana-Pacific Corporation periodically updates and revises its product information. To verify that this version is current, contact the nearest sales office, visit [LPCorp.com](http://LPCorp.com), or call 1-888-820-0325.